

TEST REPORT

For

HF/50MHz TRANSCEIVER

In conformity with

FCC CFR 47 Part15 Subpart B (CSR)

Model : FT-891

FCC ID : K6620651X50

Test Item : HF/50MHz TRANSCEIVER

Report No. : ERY1603P24R1

Issue Date : 24 Mar. 2016

Prepared for

YAESU MUSEN CO., LTD.
Tennozu Parkside Building 2-5-8 Higashi-Shinagawa,
Shinagawa-ku, Tokyo 140-0002 JAPAN

Prepared by

SGS RF Technologies Inc.
3-5-23, Kiyatamata, Tsuzuki-ku, Yokohama, 224-0021, Japan
Telephone: +81+(0)45- 550-3520
FAX: +81+(0)45- 592-7506

This document is issued by the Company subject to its General Conditions of Service printed overleaf, available on request or accessible at www.sgs.com/terms_and_conditions.htm and, for electronic format documents, subject to Terms and Conditions for Electronic Documents at www.sgs.com/terms_e-document.htm. Attention is drawn to the limitation of liability, indemnification and jurisdiction issues defined therein. Any holder of this document is advised that information contained hereon reflects the Company's findings at the time of its intervention only and within the limits of Client's instructions, if any. The Company's sole responsibility is to its Client and this document does not exonerate parties to a transaction from exercising all their rights and obligations under the transaction documents. This document cannot be reproduced except in full, without prior written approval of the Company. Any unauthorized alteration, forgery or falsification of the content or appearance of this document is unlawful and offenders may be prosecuted to the fullest extent of the law.

SGS RF Technologies Inc. is managed to ISO17025 and has the necessary knowledge and test facilities for testing according to the referenced standards. The test results in this report apply only to the sample tested.

Table of contents

1	General information.....	4
1.1	Product description	4
1.2	Test(s) performed/ Summary of test result	4
1.3	Test facility	5
1.4	Measurement uncertainty.....	5
1.5	Summary of test results.....	6
1.6	Setup of equipment under test (EUT)	6
1.6.1	Test configuration of EUT	6
1.6.2	Operating condition:	7
1.6.3	Setup diagram of tested system.....	7
1.7	Equipment modifications	7
1.8	Deviation from the standard	7
2	Test procedure and test data	8
2.1	Radiated emissions	8
2.2	Conducted emissions for receiver	15
2.3	AC power line conducted emissions.....	17
3	Test setup photographs	20
3.1	Radiated emissions	20
3.2	AC power line conducted emissions.....	21
4	List of utilized test equipment / calibration	22

History

Report No.	Date	Revisions	Issued By
ERY1602P26R1	26 Feb. 2016	Initial Issue	T.Kato
ERY1603P17R1	17 Mar. 2016	Add the photo of Radiated emission test (above 1GHz)	T.Kato
ERY1603P24R1	24 Mar. 2016	Add the test result of conducted emission	T.Kato

1 General information

1.1 Product description

Test item : HF/50MHz TRANSCEIVER
Manufacturer : YAESU MUSEN CO., LTD.
Address : 43 Utsuroda, Morijuku, Sukagawa-shi, Fukushima-ken 962-0001 JAPAN
Model : FT-891
FCC ID : K6620651X50
Serial number : ES01
Hardware version : ES01
Software version : ES01
Operating frequency range : 0.03 - 56 MHz
Highest internal operating Freq. : 125.4 MHz
Receipt date of EUT : 13 Jan. 2016
Nominal power source voltages : DC 13.8 V (This is supplied by a battery)

1.2 Test(s) performed/ Summary of test result

Test specification(s) : FCC CFR 47 Part 15 Subpart B (01 Oct. 2015)
Test method(s) : ANSI C63.4: 2014
Test(s) started : 13 Jan. 2016
Test(s) completed : 23 Mar. 2016
Purpose of test(s) : Certification as the scanning receiver

Summary of test result : Complied

Note: The above judgment is only based on the measurement data and it does not include the measurement uncertainty. Accordingly, the statement below is applied to the test result.

The EUT complies with the limit required in the standard in case that the margin is not less than the measurement uncertainty in the Laboratory.

Compliance of the EUT is more probable than non-compliance is case that the margin is less than the measurement uncertainty in the Laboratory.

Test engineer

: 
T. Kato
EMC testing Department

Reviewer

: 
K. Onishi
Manager
EMC testing Department

1.3 Test facility

The Federal Communications Commission has reviewed the technical characteristics of the test facilities at SGS RF Technologies Inc., located in 472, Nippa-cho, Kohoku-ku, Yokohama, 223-0057, Japan, and has found these test facilities to be in compliance with the requirements of 47 CFR Part 15, section 2.948, per October 1, 2015.

The description of the test facilities has been filed under registration number 319924 at the Office of the Federal Communications Commission. The facility has been added to the list of laboratories performing these test services for the public on a fee basis.

The list of all public test facilities is available on the Internet at <http://www.fcc.gov>.

Registered by Industry Canada (IC): The registered facility number is as follows;

Test site No. 1 (Semi-Anechoic chamber 3m): 6974A-1

Accredited by **National Voluntary Laboratory Accreditation Program (NVLAP)** for the emission tests stated in the scope of the certificate under Certificate Number 200780-0

This report must not be used by the client to claim product certification, approval, or endorsement by NVLAP, NIST, or any agency of the Federal Government.

1.4 Measurement uncertainty

The treatment of uncertainty is based on the general matters on the definition of uncertainty in “Guide to the expression of uncertainty in measurement (GUM)” published by ISO. The Lab’s uncertainty is determined by referring UKAS Publication LAB34: 2002 “The Expression of Uncertainty in EMC Testing” and CISPR16-4-2: 2011 “Uncertainty in EMC Measurements”.

The uncertainty of the measurement result in the level of confidence of approximately 95% ($k=2$) is as follows;

AC conducted emission: ± 3.4 dB (150 kHz - 30 MHz)

RF conducted emission: ± 1.0 dB (30 MHz - 6 GHz)

Radiated emission (9 kHz - 30 MHz): ± 3.3 dB

Radiated emission (30 MHz - 200 MHz): ± 4.8 dB

Radiated emission (200 MHz - 1000 MHz): ± 6.1 dB

Radiated emission (1 GHz - 6 GHz): ± 4.5 dB

1.5 Summary of test results

Requirement	Section in specification	Result	Section in this report
Radiated emissions (30 to 2000 MHz) (*)	15.109	Complied	2.1
Conducted emission for receiver	15.111	Complied	2.2
AC power line conducted emissions	15.107	Complied	2.3
38 dB Rejection (cellular band)	15.121 (b)	- (**)	-

(*) The highest internal operating frequency is 125.4 MHz

(**) This item was not tested in this report.

1.6 Setup of equipment under test (EUT)

1.6.1 Test configuration of EUT

Equipment(s) under test

No.	Item	Manufacture	Model No.	Serial No.
A	HF/50MHz TRANSCEIVER	YAESU MUSEN CO., LTD.	FT-891	ES01
-	-	-	-	-

Support Equipment(s)

No.	Item	Manufacture	Model No.	Serial No.
B	Hand Microphone	YAESU MUSEN CO., LTD.	MH-31A8J	YTS30
C	Remote Control Keypad	YAESU MUSEN CO., LTD.	FH-2	YTS02
D	External Speaker	YAESU MUSEN CO., LTD.	MLS-100	064
E	DC Power Supply	YAESU MUSEN CO., LTD.	FP-1030A	1108122610

Connected cable(s)

No.	Item	Identification (Manu.etc.)	Cable Shielded	Ferrite Core	Length [m]
1	Mic Cable	YAESU MUSEN CO., LTD.	No	No	0.6
2	Remote Cable	YAESU MUSEN CO., LTD.	No	No	1.0
3	Ext. SP Cable	YAESU MUSEN CO., LTD.	No	No	1.8
4	Key Cable	YAESU MUSEN CO., LTD.	No	No	2.0
5	RTTY/DATA Cable	YAESU MUSEN CO., LTD.	Yes	No	1.6
6	TUN/LIN Cable	YAESU MUSEN CO., LTD.	Yes	No	2.4
7	USB Cable	YAESU MUSEN CO., LTD.	Yes	No	1.7
8	GND Cable	YAESU MUSEN CO., LTD.	No	No	2.0
9	DC Cable	YAESU MUSEN CO., LTD.	No	No	2.8

1.6.2 Operating condition:

- Rx 0.03 MHz
- Rx 30 MHz
- Rx 56 MHz

1.6.3 Setup diagram of tested system

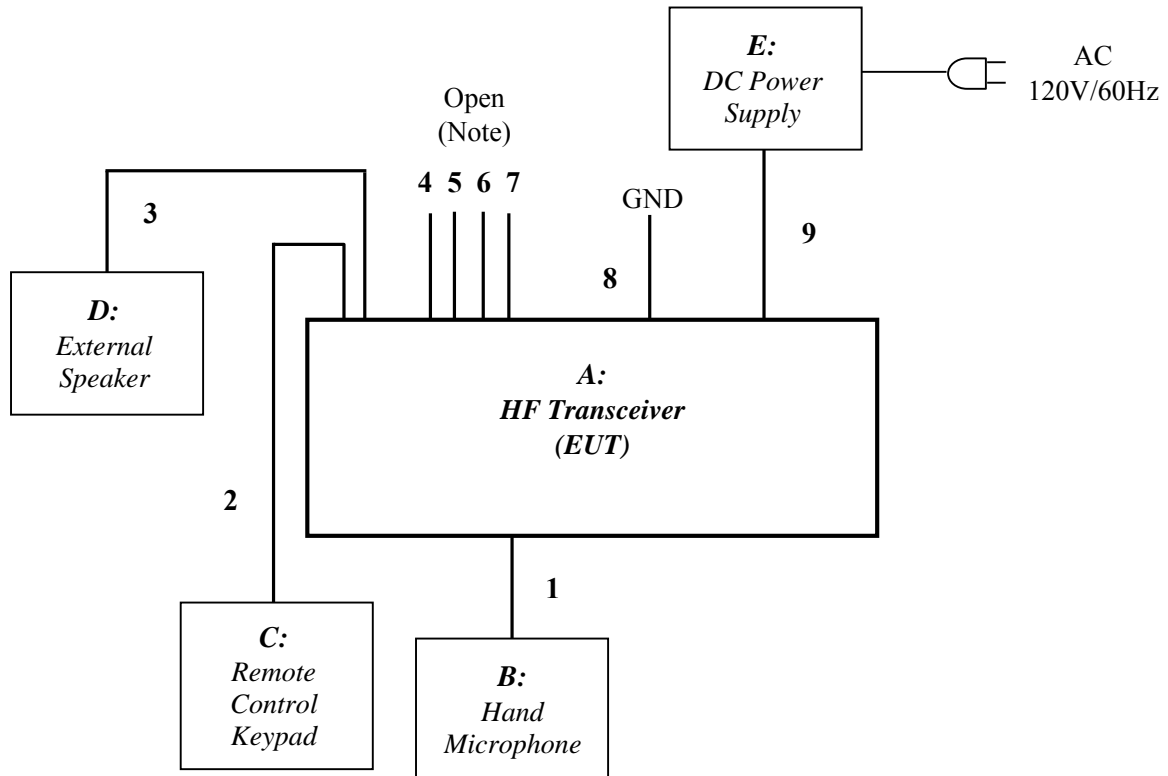

Note: The signal cable 4, 5, 6, 7 were connected to no AE by a request from the manufacturer.

1.7 Equipment modifications

No modifications have been made to the equipment in order to achieve compliance with the applicable standards described in clause 1.2.

1.8 Deviation from the standard

No deviations from the standards described in clause 1.2.

2 Test procedure and test data

2.1 Radiated emissions

Test setup

Test setup was implemented according to the method of ANSI C63.4 clause 6 “General requirements for EUT equipment arrangements and operation”, clause 8.2 and Annex H.3 “Radiated emission measurements setup”.

Test procedure

Measurement procedures were implemented according to the method of ANSI C63.4 clauses 8.2.

The EUT is placed on a non-conducted table which is 0.8 m height from a ground plane and the measurement antenna to EUT distance is 3 meters. The turn table is rotated for 360 degrees to determine the maximum emission level.

The antenna height scanned between 1 m and 4 m, and the antenna rotated to repeat the measurements for both the horizontal and vertical antenna polarizations.

The spectrum analyzer and receiver are set to the followings;

RBW=100 kHz (up to 1000 MHz) or 1 MHz (above 1000 MHz) ,

VBW= 300 kHz (up to 1000 MHz) or 3 MHz (above 1000 MHz)

Final measurement is carried out with a receiver RBW of 120 kHz (up to 1000 MHz), or 1 MHz (above 1000 MHz).

Applicable rule and limitation

FCC 15.109 Radiated emissions limits

Frequency [MHz]	Field Strength [$\mu\text{V/m}$]	Measurement Distance [m]	Field Strength [dB $\mu\text{V/m}$]
30 – 88	100	3	40.0
88 –216	150	3	43.5
216 – 960	200	3	46.0
Above 960	500	3	53.9

In the emission table above, the tighter limit applies at the band edges.

The emission limits shown in the above table are based on measurements employing a QP detector (up to 1000 MHz) or AVE/PEAK detector (above 1000 MHz).

Test results - Complied with requirement

Test equipment used (refer to List of utilized test equipment)

AC01	TR06	CL11	PR15	BA07	CL29	CL30
PR12	DH01					

Test software used

EMI1 Ver. 3.2

Calculation method

The Correction Factor and Result are calculated as followings.

$$\text{Correction Factor [dB/m]} = \text{Ant. Factor [dB/m]} + \text{Loss [dB]} - \text{Gain [dB]}$$

$$\text{Result [dB}\mu\text{V/m]} = \text{Reading [dB}\mu\text{V]} + \text{Correction Factor [dB/m]}$$

Test Data

Operating mode: Rx 0.03 MHz

Range: 30 - 1000 MHz

No.	Frequency [MHz]	Reading [dB μ V]	Factor [dB/m]	Loss [dB]	Gain [dB]	Result [dB μ V/m]	Limit [dB μ V/m]	Margin [dB]	Ant.
1	138.000	32.4	12.3	8.0	30.0	22.7	43.5	20.8	Hori.
2	700.447	32.7	18.7	11.4	29.9	32.9	46.0	13.1	Hori.
3	69.000	38.1	8.6	7.3	30.2	23.8	40.0	16.2	Vert.
4	700.384	34.0	18.7	11.4	29.9	34.2	46.0	11.8	Vert.
5	960.000	22.1	20.7	12.4	30.2	25.0	46.0	21.0	Vert.

Note: All other emissions were under noise floor.

Range: 1000 - 2000 MHz

No.	Frequency [MHz]	Reading PK [dB μ V]	Reading AVE [dB μ V]	C.Factor [dB/m]	Result PK [dB μ V/m]	Result AVE [dB μ V/m]	Limit PK [dB μ V/m]	Limit AVE [dB μ V/m]	Margin PK [dB]	Margin AVE [dB]	Ant.
1	1035.002	51.4	45.6	-11.6	39.8	34.0	73.9	53.9	34.1	19.9	Hori.
2	1173.001	49.4	43.5	-10.5	38.9	33.0	73.9	53.9	35.0	20.9	Hori.
3	1380.000	47.8	40.0	-9.6	38.2	30.4	73.9	53.9	35.7	23.5	Hori.
4	1173.001	49.5	42.3	-10.5	39.0	31.8	73.9	53.9	34.9	22.1	Vert.
5	1242.001	49.3	42.0	-10.0	39.3	32.0	73.9	53.9	34.6	21.9	Vert.
6	1380.000	47.9	40.2	-9.6	38.3	30.6	73.9	53.9	35.6	23.3	Vert.

[Chart]

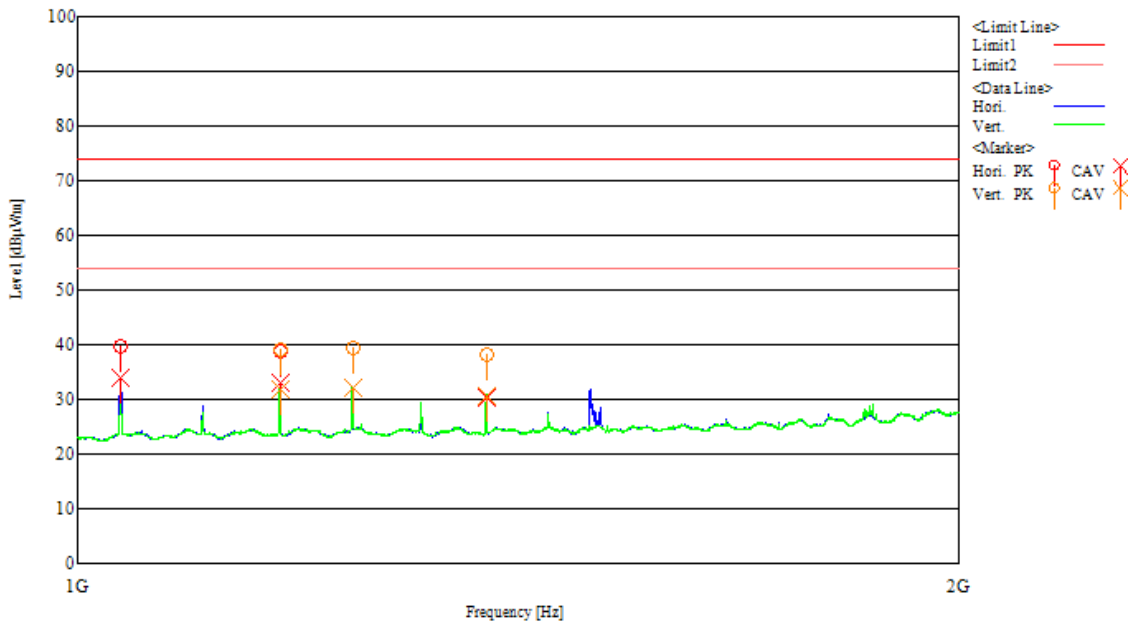
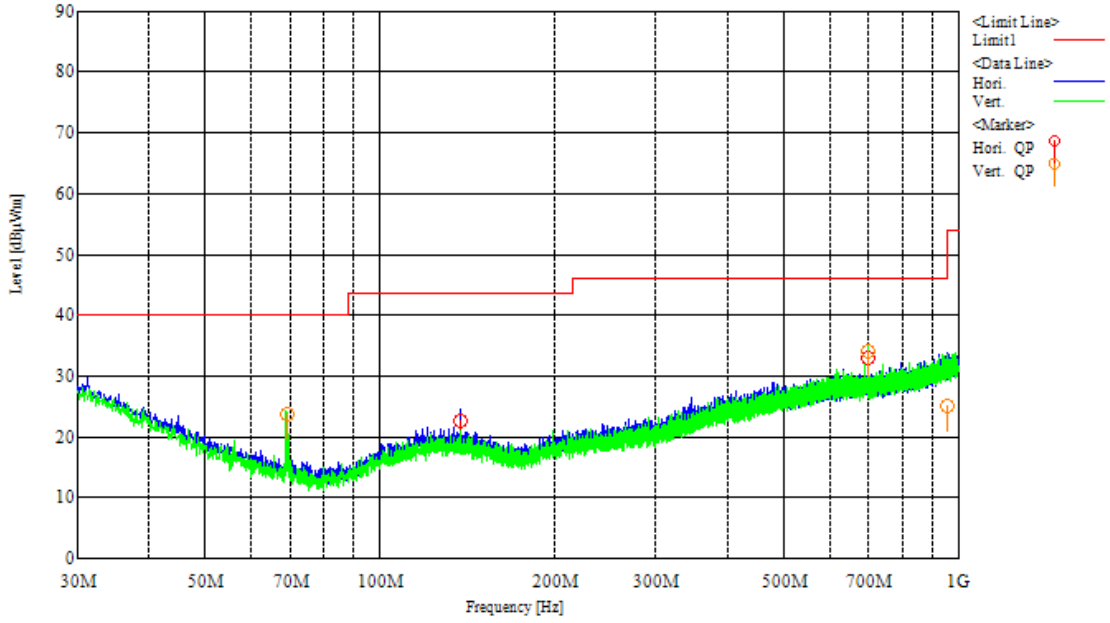

Operating mode: Rx 30 MHz

Range: 30 - 1000 MHz

No.	Frequency [MHz]	Reading [dB μ V]	Factor [dB/m]	Loss [dB]	Gain [dB]	Result [dB μ V/m]	Limit [dB μ V/m]	Margin [dB]	Ant.
1	345.000	31.4	14.5	9.5	29.9	25.5	46.0	20.5	Hori.
2	700.448	33.2	18.7	11.4	29.9	33.4	46.0	12.6	Hori.
3	69.000	38.0	8.6	7.3	30.2	23.7	40.0	16.3	Vert.
4	99.450	34.7	10.1	7.7	30.1	22.4	43.5	21.1	Vert.
5	700.384	34.1	18.7	11.4	29.9	34.3	46.0	11.7	Vert.
6	960.000	22.1	20.7	12.4	30.2	25.0	46.0	21.0	Vert.

Range: 1000 - 2000 MHz

No.	Frequency [MHz]	Reading PK [dB μ V]	Reading AVE [dB μ V]	C.Factor [dB/m]	Result PK [dB μ V/m]	Result AVE [dB μ V/m]	Limit PK [dB μ V/m]	Limit AVE [dB μ V/m]	Margin PK [dB]	Margin AVE [dB]	Ant.
1	1034.992	50.8	45.2	-11.6	39.2	33.6	73.9	53.9	34.7	20.3	Hori.
2	1173.004	49.6	43.4	-10.5	39.1	32.9	73.9	53.9	34.8	21.0	Hori.
3	1790.103	46.7	39.4	-7.3	39.4	32.1	73.9	53.9	34.5	21.8	Hori.
4	1173.009	49.0	42.1	-10.5	38.5	31.6	73.9	53.9	35.4	22.3	Vert.
5	1242.001	49.5	41.6	-10.0	39.5	31.6	73.9	53.9	34.4	22.3	Vert.
6	1988.995	46.6	37.4	-4.9	41.7	32.5	73.9	53.9	32.2	21.4	Vert.

[Chart]

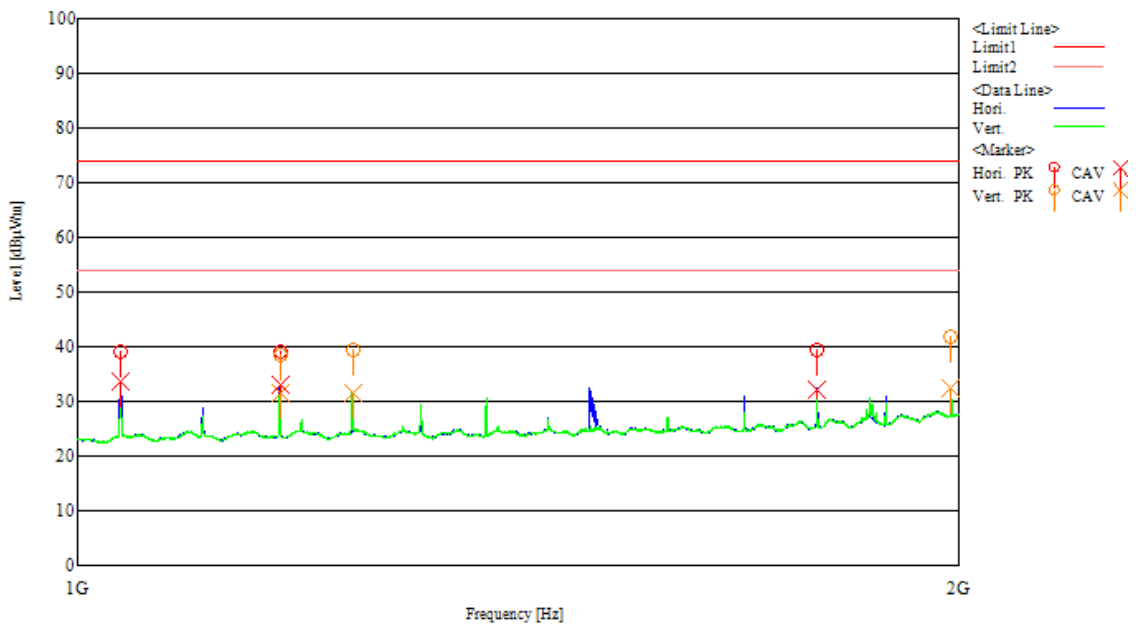
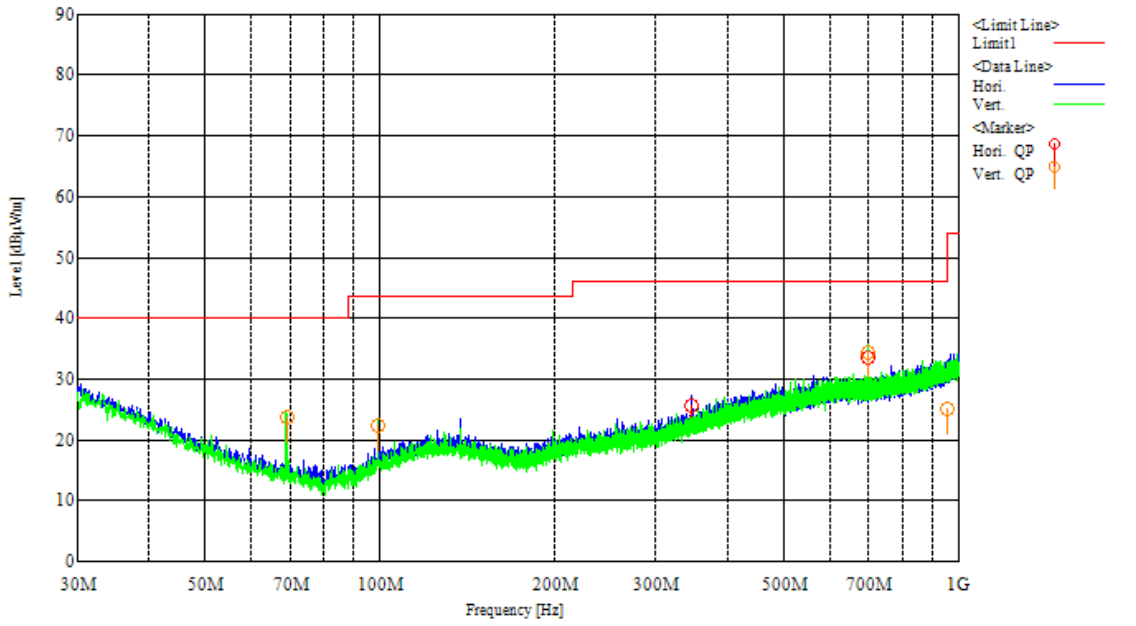

Operating mode: Rx 56 MHz

Range: 30 - 1000 MHz

No.	Frequency [MHz]	Reading [dB μ V]	Factor [dB/m]	Loss [dB]	Gain [dB]	Result [dB μ V/m]	Limit [dB μ V/m]	Margin [dB]	Ant.
1	138.000	32.0	12.3	8.0	30.0	22.3	43.5	21.2	Hori.
2	345.000	31.3	14.5	9.5	29.9	25.4	46.0	20.6	Hori.
3	700.384	32.9	18.7	11.4	29.9	33.1	46.0	12.9	Hori.
4	69.000	38.0	8.6	7.3	30.2	23.7	40.0	16.3	Vert.
5	700.384	34.3	18.7	11.4	29.9	34.5	46.0	11.5	Vert.
6	960.000	22.1	20.7	12.4	30.2	25.0	46.0	21.0	Vert.

Range: 1000 - 2000 MHz

No.	Frequency [MHz]	Reading PK [dB μ V]	Reading AVE [dB μ V]	C.Factor [dB/m]	Result PK [dB μ V/m]	Result AVE [dB μ V/m]	Limit PK [dB μ V/m]	Limit AVE [dB μ V/m]	Margin PK [dB]	Margin AVE [dB]	Ant.
1	1034.997	51.2	45.1	-11.6	39.6	33.5	73.9	53.9	34.3	20.4	Hori.
2	1103.999	48.9	40.2	-10.9	38.0	29.3	73.9	53.9	35.9	24.6	Hori.
3	1173.000	49.4	43.3	-10.5	38.9	32.8	73.9	53.9	35.0	21.1	Hori.
4	1242.001	48.8	41.3	-10.0	38.8	31.3	73.9	53.9	35.1	22.6	Vert.
5	1311.000	47.9	39.3	-9.9	38.0	29.4	73.9	53.9	35.9	24.5	Vert.
6	1380.001	47.8	39.7	-9.6	38.2	30.1	73.9	53.9	35.7	23.8	Vert.

[Chart]

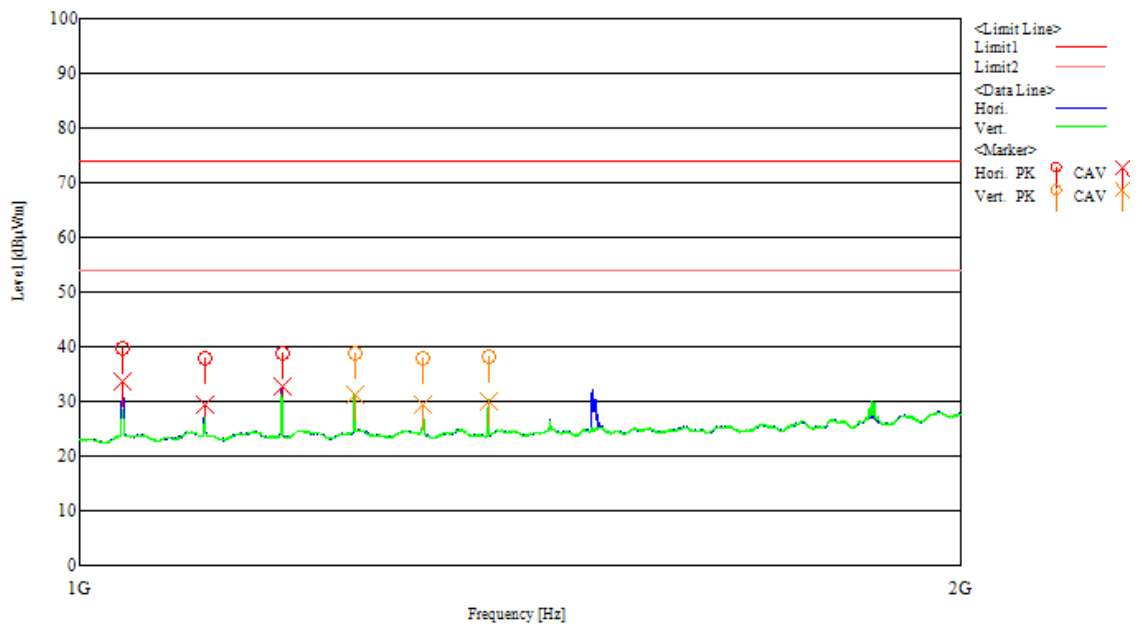
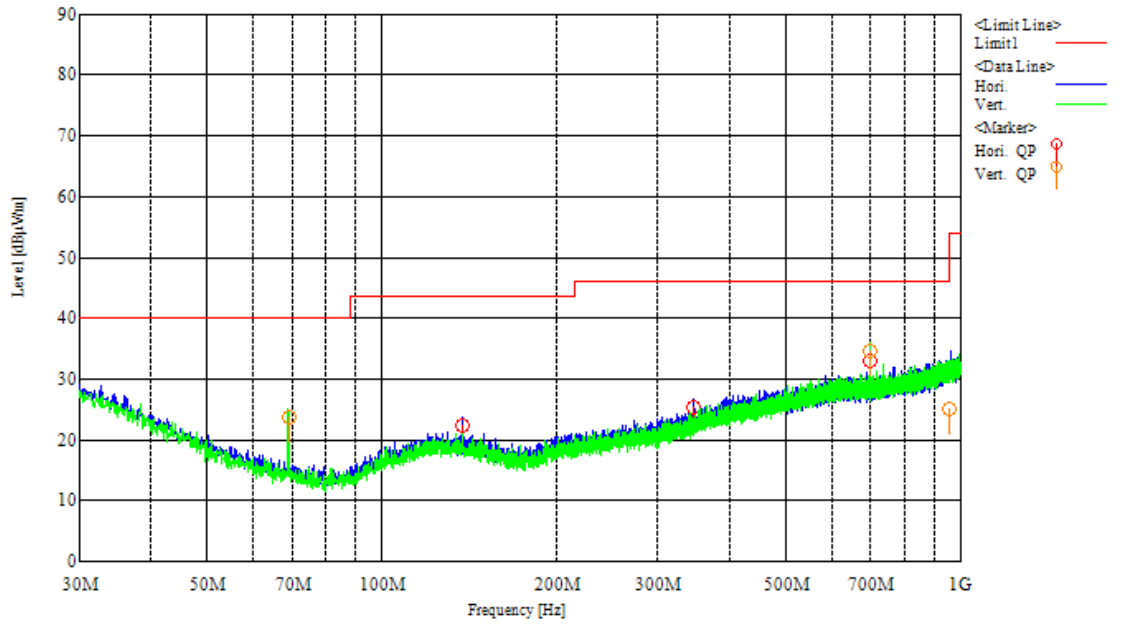

[Test condition]

Tested Date: 13 Jan. 2016
 Humidity: 36 %

Temperature: 15 degC
 Atmos. Press: 1016 hPa

2.2 Conducted emissions for receiver

Test setup

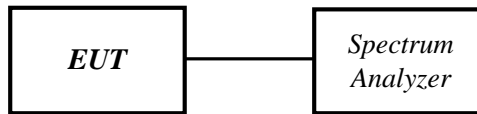

Applicable rule and limitation

§15.111 (b) Antenna power conducted limit : 2 nW (= -57 dBm)

Test equipment used (refer to List of utilized test equipment)

TR06	CL31	
------	------	--

Test results - Complied with requirement

Test Data

[The maximum spurious level at antenna port]

Operating freq. [MHz]	Frequency range 30 - 1000 MHz		Frequency range 1000 - 2000 MHz	
	Freq. [MHz]	Level [dBm]	Freq. [MHz]	Level [dBm]
0.03	69.479	-78.2	- (Note)	- (Note)
30	- (Note)	- (Note)	- (Note)	- (Note)
56	- (Note)	- (Note)	- (Note)	- (Note)

Note: No emission above noise floor was found.

[Test condition]

Tested Date: 13 Jan. 2016
 Humidity: 36 %

Temperature: 15 degC
 Atmos. Press: 1016 hPa

[Chart]

Operating mode: Rx 0.03 MHz

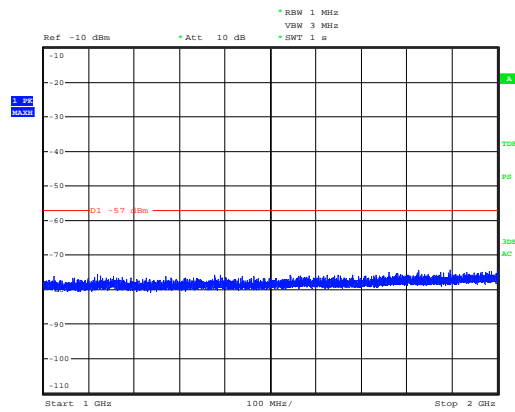
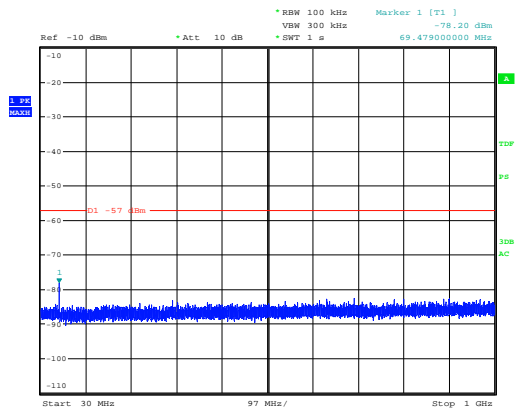

Operating mode: Rx 30 MHz

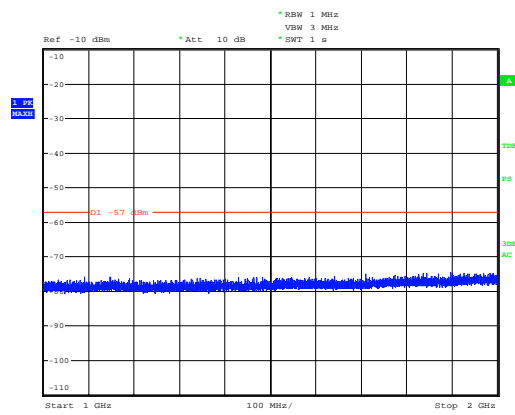
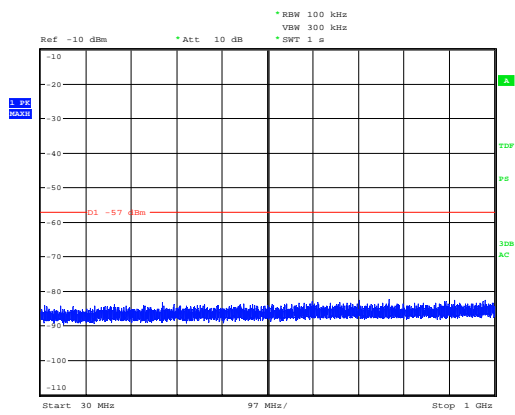

Operating mode: Rx 56 MHz

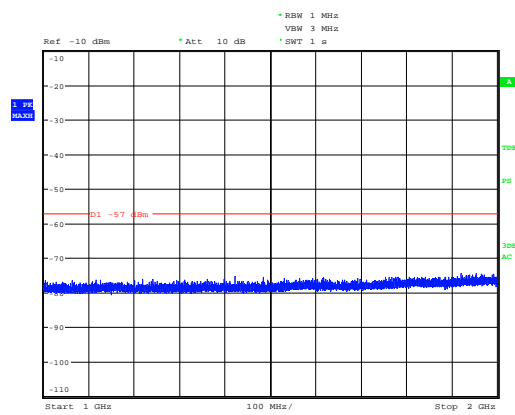
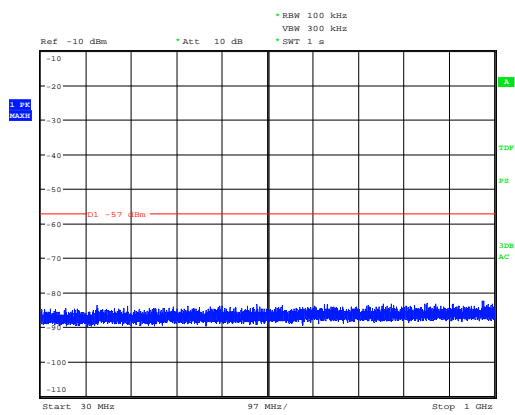

2.3 AC power line conducted emissions

Test setup

Test setup was implemented according to the method of ANSI C63.4 clause 6 “General requirements for EUT equipment arrangements and operation” and Annex H.1 “AC power line conducted emission measurements setup”.

Test procedure

Measurement procedures were implemented according to the method of ANSI C63.4 clauses 7, clause 13.1.3 and Annex H.2 “AC power line conducted emission measurements”.

Exploratory measurements were used the spectrum analyzer to identify the frequency of the emission that has the highest amplitude relative to the limit by operating the EUT in a range of typical modes of operation, cable positions, and with a typical system equipment configuration and arrangement.

Final ac power line conducted emission measurements were performed based on the exploratory tests.

The EUT cable configuration and arrangement and mode of operation that produced the emission with the highest amplitude relative to the limit are selected for the final measurement.

When the measurement value is greater than average limitation the average detection measurements were performed.

Applicable rule and limitation

§15.107 (b) AC power line conducted limits

Frequency of Emission [MHz]	Conducted emissions Limit [dBμV]	
	Quasi-peak	Average
0.15 - 0.5	66 to 56 *	56 to 46 *
0.5 - 5	56	46
5 - 30	60	50

* Decreases with the logarithm of the frequency. The lower limit applies at the band edges.

Test equipment used (refer to List of utilized test equipment)

TR09	CL18	LN05
------	------	------

Test software used

EMI1 Ver. 3.2

Calculation method

The Correction Factor and Result are calculated as followings.

$$\text{Correction Factor [dB]} = \text{ISN Factor [dB]} + \text{Loss [dB]}$$

$$\text{Result [dBμV]} = \text{Reading [dBμV]} + \text{Correction Factor [dB]}$$

Test results - Complied with requirement

Test Data

[Emission level]

Operating mode: Rx 0.03 MHz

	Freq. [MHz]	Reading QP [dB μ V]	Reading Ave [dB μ V]	Factor [dB]	Result QP [dB μ V]	Result Ave [dB μ V]	Limit QP [dB μ V]	Limit Ave [dB μ V]	Margin QP [dB]	Margin Ave [dB]	Line
1	0.15272	21.4	0.1	10.2	31.6	10.3	65.9	55.9	34.3	45.6	Va
2	0.15731	20.6	-0.2	10.2	30.8	10.0	65.6	55.6	34.8	45.6	Va
3	0.15986	20.1	-0.4	10.2	30.3	9.8	65.5	55.5	35.2	45.7	Va
4	0.15306	21.1	-0.1	10.2	31.3	10.1	65.8	55.8	34.5	45.7	Vb
5	0.15782	20.2	-0.3	10.2	30.4	9.9	65.6	55.6	35.2	45.7	Vb
6	0.16275	19.3	-0.7	10.2	29.5	9.5	65.3	55.3	35.8	45.8	Vb

Operating mode: Rx 30 MHz

	Freq. [MHz]	Reading QP [dB μ V]	Reading Ave [dB μ V]	Factor [dB]	Result QP [dB μ V]	Result Ave [dB μ V]	Limit QP [dB μ V]	Limit Ave [dB μ V]	Margin QP [dB]	Margin Ave [dB]	Line
1	0.15255	22.2	0.2	10.2	32.4	10.4	65.9	55.9	33.5	45.5	Va
2	0.15816	21.2	-0.1	10.2	31.4	10.1	65.6	55.6	34.2	45.5	Va
3	0.16156	20.5	-0.3	10.2	30.7	9.9	65.4	55.4	34.7	45.5	Va
4	0.15221	22.1	0.2	10.2	32.3	10.4	65.9	55.9	33.6	45.5	Vb
5	0.15442	21.7	0.1	10.2	31.9	10.3	65.8	55.8	33.9	45.5	Vb
6	0.15867	20.9	-0.1	10.2	31.1	10.1	65.5	55.5	34.4	45.4	Vb

Operating mode: Rx 56 MHz

	Freq. [MHz]	Reading QP [dB μ V]	Reading Ave [dB μ V]	Factor [dB]	Result QP [dB μ V]	Result Ave [dB μ V]	Limit QP [dB μ V]	Limit Ave [dB μ V]	Margin QP [dB]	Margin Ave [dB]	Line
1	0.15085	22.5	0.3	10.2	32.7	10.5	66.0	56.0	33.3	45.5	Va
2	0.15289	22.1	0.2	10.2	32.3	10.4	65.8	55.8	33.5	45.4	Va
3	0.16173	20.3	-0.3	10.2	30.5	9.9	65.4	55.4	34.9	45.5	Va
4	0.15187	22.1	0.2	10.2	32.3	10.4	65.9	55.9	33.6	45.5	Vb
5	0.15544	21.4	0.1	10.2	31.6	10.3	65.7	55.7	34.1	45.4	Vb
6	0.16309	19.9	-0.5	10.2	30.1	9.7	65.3	55.3	35.2	45.6	Vb

[Chart]

Operating mode: Rx 56 MHz

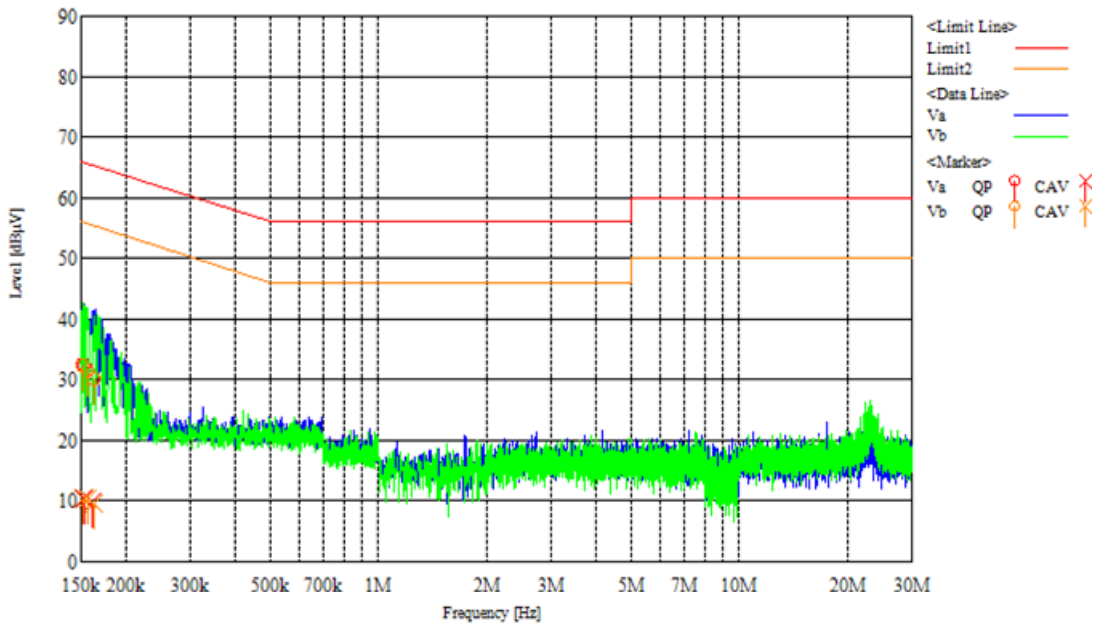

[Test condition]

Tested Date: 23 Mar. 2016
 Humidity: 47 %

Temperature: 16 degC
 Atmos. Press: 1019 hPa

4 List of utilized test equipment / calibration

RFT ID No.	Kind of Equipment and Precision	Manufacturer	Model No.	Serial Number	Calibration Date	Calibrated until
AC01(EM)	Anechoic Chamber (1st test room)	JSE	203397C	-	2015/4/18	2016/4/30
AC01(EG)	Anechoic Chamber (1st test room)	JSE	203397C	-	2015/11/3	2016/11/30
BA07	Biological Antenna	TESEQ	CBL6143A	26670	2016/1/25	2017/1/31
CL11	RF Cable for RE	RFT	-	-	2015/3/13	2016/3/31
CL18	RF Cable for CE	RFT	-	-	2015/5/1	2016/5/31
CL29	RF Cable 2 m	SUHNER	SUCOFLEX104PE	94709	2015/8/25	2016/8/31
CL30	RF Cable 5 m	SUHNER	SUCOFLEX104PE	MY3599	2015/8/25	2016/8/31
CL31	RF Cable 1 m	Junkosha	MWX221	1303S118	2015/11/24	2016/11/30
DH01	DRG Horn Antenna	A.H. Systems	SAS-571	785	2016/1/26	2018/1/31
LN05	LISN	Kyoritsu	KNW-407F	8-1773-2	2015/6/2	2016/6/30
PR12	Pre. Amplifier (1-26G)	Agilent Technologies	8449B	3008A02513	2016/1/29	2017/1/31
PR15	Pre. Amplifier	Anritsu	MH648A	6201156141	2015/6/13	2016/6/30
TR06	Test Receiver (F/W : 3.93 SP2)	Rohde & Schwarz	ESU26	100002	2015/9/28	2016/9/30
TR09	Test Receiver (F/W : 4.43 SP3)	Rohde & Schwarz	ESU8	100386	2016/2/2	2017/2/28

The measuring equipment, which was utilized in performing the tests documented herein, has been calibrated in accordance with the manufacturer's recommendations for utilizing calibration equipment, which is traceable to recognized national standards.